



AMERICAN LEGION AUXILIARY

*Department of Ohio, Inc.*

PO BOX 2760

ZANESVILLE, OHIO 43702-2760

OFFICE OF  
**Katie Wainwright**  
SECRETARY / TREASURER  
PHONE (740) 452-8245  
FAX (740) 452-2620  
ala\_katie@rrohio.com

November 17, 2010

To:                    Unit Presidents                    Department Executive Committee  
                          District Chairmen                    Hospital Representatives & Deputies  
                          Department Chairmen                Past Department Presidents

The enclosed information is to be distributed to Unit Chairmen and shared with all members.

- ✓ Mid-Winter Conference (Ivory) – *all members*
  - Mid-Winter Conference Information
  - Tentative Schedule
  - Housing Reservations and Directions
  - Leadership Workshop Registration Form
  - Luncheon Reservation Form
- ✓ Announced Candidates Form and Policy (white) – *All members*
- ✓ President's Message – *All members*
- ✓ Membership (gray) – *Membership Chairman and all members*
- ✓ Public Relations (ivory) – *Public Relations Chairman and all members*
- ✓ Chaplain's Whisper in the Wind (blue) – *Chaplain and all members*
- ✓ Auxiliary Emergency Fund (lavender) – *AEF Chairman*
- ✓ Constitution and Bylaws (salmon) – *C&B Chairman*
- ✓ History Plan of Action Update and Flyer (ivory) *Historian*
- ✓ National Security (gray) – *National Security Chairman*
- ✓ Poppy (pink) – *Poppy Chairman*
- ✓ VA&R Home Service (buff) – *VA&R Chairman*
- ✓ VA&R (white) – *VA&R Chairman*
- ✓ VA&R VA Home needs list (white) – *VA&R Chairman*
- ✓ VA&R Patterns (white) – *VA&R Chairman*
- ✓ VA&R Mid Year Report Form (white) – *VA&R Chairman*
- ✓ Auxiliary Charm Bracelet Flyer (white) – *All members*
- ✓ Norman Rockwell Moments Flyer (colored) – *All members*

Sincerely,

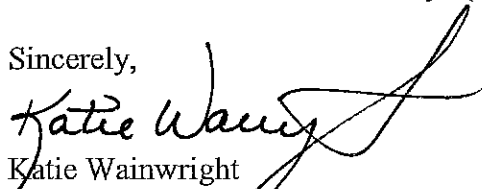

Katie Wainwright  
Department Secretary/Treasurer

*May your holidays be filled with peace and joy.  
Merry Christmas from the Department Headquarters Staff:  
Rachel, Heather, Dean, and Katie.*



***AMERICAN LEGION AUXILIARY***  
***Department of Ohio***

***MID-WINTER CONFERENCE***  
***Crowne Plaza Columbus North, Columbus, Ohio***  
***January 14 & 15, 2011***

The American Legion Auxiliary Department of Ohio Mid-Winter Conference will be held January 14 and 15, 2011 at the Crowne Plaza Columbus North, 6500 Doubletree Avenue, Columbus, Ohio.

Department Leadership Chairman Rene' Reese will conduct a Leadership Workshop on Friday from 10:00 AM to 3:00 PM. All members are encouraged to attend. Reservations and a \$5.00 fee per attendee are required.

The Department Juniors Activities Committee has planned an exciting meeting for the Juniors so be sure to bring them along.

The Department Chairmen will have plenty of brochures and information regarding their programs at the exhibit tables on Friday evening and Saturday morning.

Friday evening's session will begin at 7:00 PM. In honor of Department President Linda's Theme, she is asking that all attending Friday night's session come dressed as a patriotic character from history or in your patriotic attire. A National Security/Legislative Awareness Program will include guest speakers.

Saturday's session will reconvene at 9:00 AM with updates from the Department Chairmen and special guest Central Division Vice President Donna Fueling. A luncheon will be served where Hospital Representatives will be honored guests. The Conference will conclude with the famous Membership Skit featuring the District Presidents and directed by Department Membership Chairman Vi Grzybowski.

For housing reservations, please call (614) 885-1885 or (800) 996-8916 and refer to the American Legion Auxiliary. Rooms are \$98.00 plus tax. Reservations must be made by December 22, 2010. Cancellation of any reservation must be made 48 hours prior to arrival date and confirmed by the hotel cancellation number.

Please plan to attend, enjoy the fun and fellowship, and learn more about the programs of the American Legion Auxiliary.

***"High On Patriotism"***

**MID-WINTER CONFERENCE**  
**Crowne Plaza Columbus North**  
**January 14 & 15, 2011**

**Tentative Schedule**

**Friday, January 14, 2011**

9:30 AM	Leadership Registration
10:00 AM – 3:00 PM	Leadership Session (Reservations Required)
10:00 AM	Department Finance Committee Meeting
11:00 PM	Department Executive Committee Meeting
4:00 PM	A&G Test Judging,(Dept Americanism & Dept President ONLY) Afghan Put Together Project
5:00 PM	National Appointees & Officer's Dinner with Central Division Vice President
5:00 – 7:00 PM	Program Exhibits
7:00 PM	Mid-Winter Conference Opening
	Juniors Meeting
	Awareness Assembly <i>Vicky Buck, National Security Chairman</i> <i>Mona Shipley, Legislative Chairman</i> Veteran Hospitals' Representative Recognition <i>June Stas, Hospital Director</i>

**Saturday, January 15, 2011**

7:30AM	Hospital Representatives & Deputies Meeting with President		
9:00 AM	Mid-Winter Conference Reconvenes Juniors Meeting Central Division Vice President Donna Fuelling, Speaker Committee Reports		
	<table border="0" style="width: 100%;"> <tr> <td style="vertical-align: top;"> <i>Americanism</i>  <i>Auxiliary Emergency Fund</i>  <i>Buckeye Girls State</i>  <i>Chaplain</i>  <i>Children &amp; Youth</i>  <i>Community Service</i>  <i>Constitution &amp; Bylaws</i>  <i>Convention</i>  <i>Education</i> </td> <td style="vertical-align: top;"> <i>Historian</i>  <i>Leadership</i>  <i>Music</i>  <i>Past Presidents Parley</i>  <i>Poppy</i>  <i>Public Relations</i>  <i>Unit Development &amp; Revitalization</i>  <i>Veterans Affairs &amp; Rehabilitation</i> </td> </tr> </table>	<i>Americanism</i> <i>Auxiliary Emergency Fund</i> <i>Buckeye Girls State</i> <i>Chaplain</i> <i>Children &amp; Youth</i> <i>Community Service</i> <i>Constitution &amp; Bylaws</i> <i>Convention</i> <i>Education</i>	<i>Historian</i> <i>Leadership</i> <i>Music</i> <i>Past Presidents Parley</i> <i>Poppy</i> <i>Public Relations</i> <i>Unit Development &amp; Revitalization</i> <i>Veterans Affairs &amp; Rehabilitation</i>
<i>Americanism</i> <i>Auxiliary Emergency Fund</i> <i>Buckeye Girls State</i> <i>Chaplain</i> <i>Children &amp; Youth</i> <i>Community Service</i> <i>Constitution &amp; Bylaws</i> <i>Convention</i> <i>Education</i>	<i>Historian</i> <i>Leadership</i> <i>Music</i> <i>Past Presidents Parley</i> <i>Poppy</i> <i>Public Relations</i> <i>Unit Development &amp; Revitalization</i> <i>Veterans Affairs &amp; Rehabilitation</i>		
12:30 PM	Luncheon with Honored Guests <i>Hospital Representatives</i>		
1:30 PM	<i>Junior Activities &amp; Membership Skit</i>		
8:00 PM	American Legion Dance, Ramada Inn Convention Center, Columbus Ohio		



**2011 MID-WINTER CONFERENCE  
HOUSING RESERVATIONS  
January 14-16, 2011**

*Crowne Plaza Columbus North  
6500 Doubletree Avenue  
Columbus, Ohio 43229-1145*

*(614) 885-1885 or (800) 996-8916*

Please call for reservations and refer to the American Legion Auxiliary. Be sure to ask for a confirmation number and if you need to cancel, please secure a cancellation number.

*Single or Double - Price: \$98.00 +16.75% Tax (\$16.42) = \$114.42  
Reservation Cut-Off Date – December 22, 2010*

Check-in time is 4:00 PM and checkout time is 12:00 AM. The hotel will assess a \$25.00 late checkout fee to those who choose to checkout after 12:00 AM.

The Crowne Plaza Columbus North has a 100% Non-Smoking Policy, which includes all guest rooms, restaurants, lounges, meeting rooms, public space, and employee work areas. There will be a \$250.00 recovery fee for guests who do not comply.

Directions from I-71: Take the Route 161 Exit #117. Turn West onto Route 161. Turn right on Busch Boulevard. Go three (3) traffic lights to Kingsmill Parkway and turn right. Kingsmill goes directly into the Crowne Plaza Parking Lot.

*“High on Patriotism”*

**MID-WINTER CONFERENCE**  
**Crowne Plaza, North**

**Luncheon Reservation Form**  
**Saturday, January 15, 2011**

**All reservations must be received in Department Headquarters and paid for by Friday, January 7, 2011. Make checks payable to American Legion Auxiliary and earmarked Mid-Winter Luncheon.**

**Mail to: American Legion Auxiliary,  
PO Box 2760, Zanesville, Ohio 43702-2760.**

**MENU**

*Slow Roasted Turkey sliced with fresh Cranberry Sauce  
Herb Stuffing, Roasted Turkey Gravy  
Served on a corn dusted Kaiser Roll  
Along with Pasta Salad, Potato Chips, Kosher Dill Pickle  
Chef's Choice Dessert  
Coffee, Hot Herbal Teas & Iced Tea*

**PRICE: \$19.00      DEADLINE: Friday, January 7, 2011**  
*(Tickets are to be picked up in the Department  
Headquarters Office at the Crowne Plaza Hotel)*

-----

**MID-WINTER CONFERENCE LUNCHEON**  
**Saturday, January 15, 2011**

Number of Tickets requested \_\_\_\_\_ X \$19.00 = \$ \_\_\_\_\_

Check # \_\_\_\_\_

**Please hold tickets in the name of:**

\_\_\_\_\_



# AMERICAN LEGION AUXILIARY

*Serving veterans, their families and their communities*

## Department of Ohio 2010-2011 Mid-Winter Conference

### ***LEADERSHIP SESSION REGISTRATION FORM***

***Friday, January 14, 2011***

***10:00 AM – 3:00 PM***

Department of Ohio Leadership Chairman Rene' Reese will conduct a Leadership Session on Friday, January 14, 2011 at the Crowne Plaza Columbus North, 6500 Doubletree Avenue, Columbus, Ohio. Registration opens at 9:30 AM and the session will be from 10:00 AM to 3:00 PM. Registration fee is \$5.00. Lunch will be on your own. All Unit members are invited and encouraged to attend. Please send the completed registration form with \$5.00 per participant by January 7, 2011 to:

American Legion Auxiliary  
Department of Ohio  
PO Box 2760  
Zanesville, Ohio 43702-2760

---

### ***Leadership Session Friday, January 14, 2011***

Name	Address	Phone Number
1. _____	_____	_____
2. _____	_____	_____
3. _____	_____	_____
4. _____	_____	_____

Unit # \_\_\_\_\_ District # \_\_\_\_\_ Total registered \_\_\_\_\_ @ \$5.00 = \$ \_\_\_\_\_



AMERICAN LEGION  
**AUXILIARY**

*Serving veterans, their families and their communities*

From the Office of:  
**Katie Wainwright**  
Secretary/Treasurer  
Department of Ohio, Inc.

**TO:** Unit Presidents

**FROM:** Katie Wainwright, Department Secretary

**DATE:** November 17, 2010

**SUBJECT: CANDIDATES FOR 2011-2012 DEPARTMENT OFFICES**

A Member wishing to be an announced candidate for Department Office must complete and return this form to Department Headquarters by May 1 of the year of elections. Unit Presidents are asked to share this information and make this form available to all members upon request.

**Announced Candidate for the Office of:** \_\_\_\_\_

Name of Candidate: \_\_\_\_\_

Address: \_\_\_\_\_

City: \_\_\_\_\_ State: \_\_\_\_\_ Zip: \_\_\_\_\_

Home Phone: \_\_\_\_\_ Business Phone: \_\_\_\_\_

Email: \_\_\_\_\_ Cell Phone: \_\_\_\_\_

Unit Name \_\_\_\_\_ Unit # \_\_\_\_\_ District # \_\_\_\_\_

Endorsed by Unit? Yes \_\_\_\_\_ Date: \_\_\_\_\_ No \_\_\_\_\_

Endorsed by District? Yes \_\_\_\_\_ Date: \_\_\_\_\_ No \_\_\_\_\_

Signature of Candidate \_\_\_\_\_ Date \_\_\_\_\_

Return to Department Headquarters by **May 1, 2011:** American Legion Auxiliary  
PO Box 2760  
Zanesville OH 43702

*Please see Policy regarding Candidates for Department Office on reverse.*

## **POLICY REGARDING CANDIDATES FOR DEPARTMENT OFFICE**

### **CANDIDATES FOR DEPARTMENT OFFICE-Paragraph 13 of 2010-2011 Department Policy**

- a. Any Unit member in good standing is eligible to hold a Department Office.
- b. All candidates seeking a Department Office must submit a Letter of Intent to Department Headquarters by April 1 of the year of elections.
- c. Each District may endorse no more than one candidate for a Department Office. A letter of endorsement may be submitted to the Department Headquarters by April 1 of the year of elections to be published in the May, June, July issue of the Buckeye Messenger.
- d. A candidate seeking a District's endorsement for a Department Office may only be endorsed by a majority vote of delegates attending a District Summer Convention.
- e. A Candidate may use either a letter or flyer (not both) to announce her candidacy to the Units. The reproduction of this announcement shall be at the candidate's expense. The candidate shall send her announcement to Department Headquarters no later than April 30<sup>th</sup> for inclusion in the May Bulk Mailing to Unit Presidents.
- f. The candidate may have one poster, not to exceed 22" x 28", announcing her candidacy. This poster may have a picture of any size and may be placed at the entrance of the Convention Hall. Requests and payment for display easels must be into Department Headquarters at least two (2) weeks prior to Department Convention.
- g. All Department Officer candidates may visit each District caucus as a group.
- h. There will be no campaign material or campaigning allowed in the convention center or hall. Pages will be instructed to ask individuals to remove the material as they enter or will be asked to leave the Convention Hall.
- i. All Department Officer candidates may have a Joint Reception to be coordinated by Department Headquarters held at a time that does not conflict with any Auxiliary convention activities including the Joint Session. Light refreshments are to be provided by the candidates. Campaign materials are permissible ONLY during this time.
- j. Candidates for any office shall be nominated by a Delegate of their choosing other than the Department President, Department First Vice President, Department Second Vice President, Department Secretary/Treasurer, or the National Executive Committeewoman.
- k. The Presiding Officer will ask for further nominations prior to presenting all candidates to the delegation before the election.
- l. Each candidate may address the Department Convention for two (2) minutes when introduced.



A message from your President,

**Congratulations to the Dept. of Ohio! Ohio was awarded \$500.00 from National for being one of the top three Departments to have the most new charters started this past year. Good job!**

The Holidays are upon us and soon the cold snow will be blowing. This year is going by very quickly. Help is needed for our military and their families. The RISFAC meetings (Regional Inter Service Family Assistance) we have been attending have asked us to donate Wal-Mart and Kroger gift cards in the amount of \$10.00, \$20.00 or \$40.00 to distribute to our military families as needed. They are especially needed around the Holiday time. Please send your donations or gift cards to Vicky Buck or myself so we can keep track of the dollar amount spent for our reporting. We then send them to our military contacts for distribution to our military throughout Ohio as needed.

## Mid - Winter

Soon it will be time for our Mid-Winter Conference. I hope you will take time to join us because there will be so much happening. The Central Division Vice President will be visiting us, as well as, the National Jr. President, Sabrina Cobb from Ohio. Please bring your Juniors so they have a chance to meet and work with her. There will be a Leadership Workshop on Friday afternoon and Vicky Buck will be holding a put-together of her afghan project. Please come in costume of your favorite Patriotic character or dress in red, white and blue on Friday for opening session. We will be looking for the most original and best dressed. We will all be "High on Patriotism" in our red, white and blue.

My special project, Military Family Assistance, is off and running. Please plan a fund raiser in your District or Unit and let's show our military that we truly are a helping hand to them. There are already soldiers who have applied for our assistance so we know the need is there. We have only had donations given from three Districts and our goal is to raise \$10,000.00. This would enable us to help ten families. I am hoping that the other Districts will soon get their fundraisers planned. I am asking that we have at least one fundraiser hosted from each District. Both Vicky and myself would like to be invited and are willing to work alongside of you, so give us a call. We're willing to do almost anything for such a good cause. I'll even take a pie in the face.

Wishing you a very Merry Christmas and Happy New Year! God bless you and please remain.....High on Patriotism.

Yours in service,

*Linda Glose, President*



# Membership

November, 2010  
Vi Grzybowski, Chairman  
[vikay@accesstoledo.com](mailto:vikay@accesstoledo.com)

## *“Traveling State Route 1 for Membership”*

Wind up your cars and keep traveling for membership. While some units have experienced detours and a few road blocks, none have run out of gas. Department has really run into detours and a major road block, almost as devastating as a rock slide. It takes time for the road crews to clear the debris but no casualties reported. District Presidents have done their best to direct their units around these mishaps but everyone gets caught up in the “Orange Poppy Barrels” around Ohio.

Due to many road blocks this year I am extending the Milestone #2 of 70% to December 7, 2010, Pearl Harbor Day, another honor for our veterans. Please REMEMBER, all dues received in Department are date stamped when they arrive and turn-in credit is given as stamped. If you got your dues in prior to the Milestone dates you WILL get the credit and certificate for your hard work.

This is a very difficult year with not up to date reports to help encourage our Districts and Unit Presidents. Please be patient with the quirks of the new system, you will receive the credit each of you has earned. As the department Chairman it is even more difficult to encourage and praise you for your awesome work. All I can say from the day I spent in headquarter working with Department Membership Clerk Heather, I fully understand her frustration with the new system and why we are where we are with no reports.

Milestone # 2 - 70% - December 7 (Pearl Harbor day)

Milestone #3 - 80% - December 31, 2010, Many Units are so close.

### **NEW INCENTITIVE!**

**To each of the first 11 (for the year 2011 membership year) who obtain goal, they will receive special recognition at Mid-Winter Conference!**

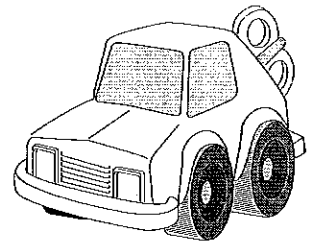

Don't forget the other incentives with ending dates of December 31<sup>st</sup>, 2010

- Incentive #3 – To the UNIT with 95% or more renewals only by Dec. 31, 2010
  - \$50 to two Units (drawn at Mid-Winter).
- Incentive #4 – To the UNIT at GOAL or above by Dec. 31, 2010
  - \$100 to two Units (drawn at Mid-Winter).
- Incentive #5 – To the UNIT with the BEST PLAN to increase membership
  - \$50 at Mid-Winter (based on a narrative of 300 or less words received by December 31, 2010).
    - Share your story or your plan to increase the Unit's membership. In a short story explain what your Unit's “Plan of Action” or your “Road Trip” in your community will do to retain your current members and how you will attract new senior and junior members.

Happy Thanksgiving! (if received in time) I am also wishing all of you a very Merry Christmas and a Happy New Year.

Keep *“Traveling State Route 1 for Membership”* and let's make Ohio a Goal state this year.

November Bulk Mailing 2010

"From National"

# The Power of Six Personal Touches

By: Marcia Wheatley, National Membership Committee

As the saying goes, "you only get one chance to make a first impression." First impressions are key to retaining new members during that crucial time when they are determining if they fit into the culture of the organization. *The Personal Touches of Membership Campaign* focuses on reaching out to new members, at least six times during the first ten months of membership to reinforce their values to your unit. It's important to maintain personal contact with all members throughout the year, not just at renewal time.

**First Touch:** New members receive a phone call or email from the Unit President welcoming them to the Unit and inviting them to the next meeting.

**Second Touch:** Within a week or two of the new member joining the Unit, an officer or membership chairman from outside the Unit (District, County and or Department) will make a call or send an email welcoming the new member to the Unit and thanking them for their membership.

**Third touch:** Within two weeks of the new member's acceptance by the Unit, the new member should receive their membership card, an upcoming events calendar, contact information sheet for officers and chairmen, information on the unit, department and national website/Facebook page and a copy of the latest Unit/Post newsletter.

**Fourth Touch:** Within 30 days of the new member's acceptance into the Unit, one or more current members schedule a face to face meeting. Questions about the unit and organization are answered at this time.

**Fifth Touch:** Within the first 6 months of membership, a member of the unit should contact the new member to see how her membership is going. Have you been to any meetings? Did you find them informative? We have a number of committees that are looking for talented people. Do you have any interest in serving on \_\_\_\_\_ committee? Would you like to assist with \_\_\_\_\_ project/activity?

**Sixth Touches:** At least a month before the start of the next membership drive, the Unit Membership Chairman should contact the member to see how her membership is going. The member should be informed she will be receiving a renewal notice soon and asked to send it back quickly.

The best member is one that already belongs to the Unit. Therefore, it is important that touches five and six be used to retain all members beyond their first year of membership.

Based on the *Seven Touches of Membership* study done by association researcher Dave Nygaard of Nygaard Research.



# The

# Flying Patriot

Volume 1, Issue 3  
Editor

Karen Peel,

Page 1

District Presidents

Dates To Remember

Page 2

District 2, 9 & 10 Articles

## DISTRICT PRESIDENTS

### 1<sup>ST</sup> DISTRICT

Denise Conrad

### 2<sup>ND</sup> DISTRICT

Shirley Maurer

### 3<sup>RD</sup> DISTRICT

Robyn Cooper

### 4<sup>TH</sup> DISTRICT

Terri Croswait

### 5<sup>TH</sup> DISTRICT

Nancy Longbrake

### 6<sup>TH</sup> DISTRICT

Tina Brown

### 7<sup>TH</sup> DISTRICT

Jane Montgomery

### 8<sup>TH</sup> DISTRICT

Nancy Brown

### 9<sup>TH</sup> DISTRICT

Martha Setlock

### 10<sup>TH</sup> DISTRICT

Janice Stevenson

### 11<sup>TH</sup> DISTRICT

Ginger Rutter

### 12<sup>TH</sup> DISTRICT

Mary "Beth" McKee

### 13<sup>TH</sup> DISTRICT

Pat Trusnick

### 14<sup>TH</sup> DISTRICT

Jean Patrick

## DATES TO REMEMBER

### November 2

Election Day

### November 6

Department President Linda Close Homecoming –  
Mansfield

### November 7

Daylight Savings Time Ends – Turn back your clock!

### November 11

Veteran's Day

### November 13

SAL Commander Rex Buchs Homecoming – Fairport  
Harbor

### November 25

Happy Thanksgiving

### December 1

Hanukkah Begins at Sundown

### December 7

Pearl Harbor Day

### December 21

Winter Begins

### December 25

Merry Christmas

## *A Moment For You . . .*

*You're already wonderful! Most of us have a mental*

*List of qualities we wish we had, a vision of our "perfect" self. But nobody's perfect, and you don't need*

*Fixing! In fact, the only self-improvement plan you*

*Should consider is one that reminds you to celebrate*

*All your strengths and feel good about yourself. Because there is no reason not to!*

**DISTRICT 2 PRESIDENT – SHIRLEY MAURER** continued from page 1

Hello – my name is Shirley Maurer and I am the 2<sup>nd</sup> District President. This is my second year as President. I truly believe that the first year is a “learning” experience and I have learned a lot! I belong to New Bremen Unit 241 where we have Over 200 members in our unit. I became actively Involved in the American Legion Auxiliary nine Years ago when I started as the District VA & R Chairman, which I loved doing. I believe that we Need to help our veterans in any way that we can Because they gave so much of themselves for the Freedom that we have today. Without our Veterans, where would we be? Our district is just Starting the new year. We had our District Fall Conference on October 10<sup>th</sup>. Our guest speaker Was Vi Gryzbowski. Our District is supporting The HAP project. In December, we will be going To the Dayton VA Hospital to distribute ditty Bags to the veterans. They really appreciate What we do for them. In closing, I want to wish Linda, Vi & Karen a most successful year as Officers of this GREAT organization.

**DISTRICT 9 PRESIDENT – MARTHA SETLOCK**

The ladies of the 9<sup>th</sup> District have been very busy So far this year. In October – McKinley Unit 76 ,Held a food drive for the Youngstown VA Clinic Pantry. The Auxiliary purchased \$100 in food to Kick off the drive. All the items will be delivered Before Thanksgiving. Howland Unit 700 – held There annual car show on September 11<sup>th</sup> at The Ponderosa. They had a band and awarded Many trophies. The Auxiliary had tables and Sold raffle tickets for baskets. During the month Of September, Ponderosa donates 10% of each Member’s bill to the Post. Palmer-Roberts American Legion Family had their annual POW/MIA program on September 21. This Program is well attended. Our Junior members And SAL members assisted with the “setting the

Missing man table.” They also presented a rose To each of the members representing the five Branches of service. The Post was honored to Have American Legion Commander Dennis Clausing and his wife Barbara in attendance. A Week later the color guard and Auxiliary President attended the funeral at Calvery Cemetery of a soldier that has been MIA since WWII. His remains, including military tags, were Found in 2007-2008 in a field between Vossenach And Hurtengen.

**DISTRICT 10 PRESIDENT – JANICE STEVENSON**

Karen Peel has asked me to write a little Something for the Flying Patriot. I thought about It and decided that I would tell you about the Love of my life, my husband – Jody. Jody is a Disabled Army veteran that served from 1981-1992. I was not married to him while he was serving, I got the wounded warrior that came Home. Jody suffers from PTSD, spinal stenous, Herniated back discs, vision issues, knee joint Trauma, skin diseases and various other Conditions. One night while playing pool with his Brothers, Jody was told he couldn’t get a date even if he advertised for one. As a joke, he placed a personal ad in the local newspaper. I answered the ad! Our first date was Oct. 17, 1995. We were engaged on October 31, 1995 and married on April 20, 1996. Answering the ad was the best decision that I have ever made. We have truly lived up to the vows that we made to each other almost 15 years ago. “For better or for worse, for richer or poorer, in sickness and in health”. Like any other marriage, we face trials and troubles, but with Jody’s ailments, it makes Things a little more challenging. Him having three Children, also added to the challenge. We now have four! Jody asked me to sing to him on our wedding day. I sang George Strait’s “Cross My Heart”. I still sing it to him on our anniversary every year, no matter if we are at home or at OVH Poppy Shop! I am proud to be the wife of this wounded warrior – my hero!

### WHISPERS IN THE WIND #3

Isn't this a wonderful time of year? The air is crisp; the leaves are vibrant with color while pumpkins and scarecrows decorate our porches. Our units have served cider and donuts to our hospitalized veterans all the while hoping our Halloween costumes would bring them an extra smile. This past week we then took a moment to thank our veterans and our military for serving our beloved nation.

This Veterans Day was extra special for my family. My nine month old granddaughter (and Unit 19 Junior member!), Calista, watched intently at our Legion Post flag raising and program. It seemed she knew something special was taking place. Her great auntie, my sister Robin, held her close as we recited the Pledge of Allegiance and I gave the benediction. The sun was shining and all was well in God's world at that moment. I know many of our chaplains were having similar experiences and this makes me smile.

We now are readying ourselves for Thanksgiving. Turkey with all the trimmings, Ham and sweet potatoes, and pie, pie, and more pie....My grocery list is a mile long. More importantly, though, Thanksgiving is about friends and family and being thankful for all of God's blessings and for His strength to get through the tough times as well. As chaplain, urge your unit members to uplift our veterans and soldiers in their Turkey Day prayer.

As soon as you wash the dishes and eat that last turkey sandwich, you will be preparing for Hanukkah and Christmas. Send cards to your unit shut ins, reminding them they are still an intricate part of our membership. If you have an afternoon, take another unit member with you to visit one or two of these wonderful ladies. You don't have to know them to visit—there are ladies in my unit I have never worked with, but know them through our cards. They are special and have great insight into our auxiliary programs. Remember to offer prayer when you leave. You will receive such a blessing for your afternoon. Share your experience with your unit at your next meeting, too.

Is your unit sending holiday cookies to our troops? Remember to add a small devotional note or prayer cloth along with your pocket flags in the box. Let them know you keep them and their families in your prayers.

Ok, so now you are ready to light the menorah, trim the tree and drink some eggnog. Please know my heart reaches out to each and everyone of you this blessed holiday season. For me, it is Christmas—my family will celebrate the birth of our Savior with great vigor while singing and feasting. For my Jewish Auxiliary sisters in the chaplaincy, you will be celebrating the rededication of the temple in Jerusalem with great brilliant lights. HALLELUJAH!

Michele N. Sandridge, Chaplain  
[michele\\_sandridge@sbcglobal.net](mailto:michele_sandridge@sbcglobal.net)  
1861 Marks Avenue Akron, OH 44305

## Auxiliary Emergency Fund - Members Helping Members



We are getting into the swing of things and I have already heard of some events that will benefit the Auxiliary Emergency Fund. When you determine the amount of money you have made at your event or how much you are able to donate, you may add this amount to the 2010-2011 DONATION DESIGNATION FORM. It is the second category down, right after AMERICANISM.

If during the year, you wish to donate to this fund and have already sent in your "Donor Designation Form", you may send it separately to Department of Ohio with a note designating the charity. Be sure to include you Unit Name, Number and District number so that you get full credit for the donation. If you have given enough (\$25.00) to get a AEF pin, please note these will be sent out in July, at the end of the organizational year. **DO NOT** send any money to me. It must be sent to American Legion Auxiliary, Department of Ohio.

At School of Instructions, I talked about trying for the Corporate Dollar. Do you have a local Wal-Mart, Home Depot or some other business in town that might be willing to help out this fund? Is there a company, plant or corporation in your town or county? Is someone in your Unit related to someone in charge of such things? Let us try to spend some money other than our own. Our members are so generous about giving. Perhaps we can use our enthusiasm to get others to help out. It is a great cause.

Some of you have informed me you will be giving \$.40 a member since this is the 40<sup>th</sup> anniversary of this Fund. A dollar a member would be greater if we try to fit it in with the motto of our National President "The Power of One". One person can make a difference, for good or for evil. Please make it for the good of others.

Be alert to any member of your Unit who would be eligible to receive a contribution from this fund. Remember, we are not only adding to the amount to be given, but also looking for eligible receivers.

FREQUENTLY ASKED QUESTIONS- requirement based on years?

ANSWER: If your current membership card reads 3 years of continuous membership, or more, you are eligible

WHAT INFORMATION SHOULD I NEVER INCLUDE ON MY APPLICATION?

ANSWER: Your Social Security Number

WHAT PAPER WORK IS REQUIRED?

ANSWER: See "Before you being filling out the AEF Application" located at [legion-aux.org](http://legion-aux.org)

Pat Dunlevy, AEF Chairman, Department of Ohio

## Constitution & Bylaws By Susan Masten

I have been asked by some members about a way to tell members what they should and shouldn't do during Unit meetings. I'm going to share something that has been included in my Unit's Constitution and Bylaws as far back as I can remember. And unfortunately, the ladies that could tell where it came from are no longer with us. We've also used this during our initiations.

### DECORUM OF THE FLOOR

1. Three raps of gavel mean stand; one rap to sit.
2. The Pledge of Allegiance is given with your right hand over your heart in this manner. Left hand should be free of all articles and at your side.
3. While the Star Spangled Banner is being played, stand and face the flag, your right hand over your heart and your left hand at your side until completion of the National Anthem.
4. When colors are posted at a meeting, do not walk between the podium and the American Flag; go to the side of the Auxiliary Flag or in back of the table.
5. When a person wishes the floor to speak, stand, address the chair as "Madam President", wait to be recognized, then proceed.
6. There will be no smoking during the opening and closing of the meeting.
7. No alcoholic beverages in the meeting room during the meeting.
8. The Junior members are required to learn the American Legion Auxiliary Preamble, therefore, so should Senior members. This is printed on the membership card and on the front page of the Constitution and Bylaws.
9. When special guests are escorted to the podium it is customary to stand. Guests are to be escorted on the Sergeant-At-Arms right arm.
10. When wearing your membership pin, always wear it over your heart.

Something else we included that teaches members why we don't break colors is the following poem. Again, I have idea where this came from or the author, *it's just always been there.*

### WHY WE DON'T WALK BETWEEN THE COLORS

#### THIS IS HALLOWED GROUND

Between these flags that proudly fly  
Let no man dare to stand  
For here our fallen comrades lie,  
This is hallowed land.  
A symbol, yes, but mark it well;  
Here let us ever humbly pause  
In memory of the lads who fell  
In fighting for our sacred cause.

On sea or land these buddies died,  
Some lie beneath a foreign sod  
In graves caressed by winds and tide,  
In spots unknown to all but God.

And so, this place is hallowed ground.  
And it shall be forever blessed  
As tho it were a grassy mound  
Beneath which gallant heroes rest.

Be ever watchful, Legionnaires,  
Of these two flags which signify  
That we should guard this spot with care  
And, if a man should dare to tread  
This spot where lie our gallant Brave,  
He desecrates those noble dead  
As tho He walked upon their grave.

# HISTORIAN (updated)

2010 - 2011

History by definition is the written record of important events and their causes. It is a story of real events and the historian is the writer of that history. Let's get "**High on Patriotism**" this year and record the history of your Unit!

*"History is the memory of things said and done"*  
*Carl L. Becker*

## OBJECTIVES

1. **OBJECTIVE** – To promote the importance of Department and Unit History by accurate record keeping through participation in the history narrative and scrapbook projects.

### Action Steps:

- a. Complete a Unit Scrapbook.
- b. Write the Unit's History in the Senior History Narrative.
- c. Complete End of Year Green Reports recording the Unit's Events throughout the year.

2. **OBJECTIVE** – To Preserve History by participating in the Veterans History Project and the Cavalcade of Memories Museum Project.

### Action Steps:

- a. Involve Junior Members in projects.
- b. Encourage Units members to cut out clippings, take photos and record your Unit's Projects.

**"There is a history in all men's lives."**

William Shakespeare, 1564-1616

The American Legion Auxiliary is celebrating its 91<sup>th</sup> anniversary this year. It is time to reconnect and energize our organization. National President Carlene Ashworth wants us to promote "The Power of One". Now is the right time to record the historical milestones of our achievements.

The Historian is asked to record the monthly events that take place in the Unit, District, and Department. This written record now becomes our connection to the past and strength for the future.

Start your story with the installation of your 2010-2011 officers. Write a paragraph each month of your Unit's activities. Next, get to know your American Legion Family better by finding out about their war time experiences. Thru the Veterans History Project great stories of the past can be preserved. See below to find out how.

# History

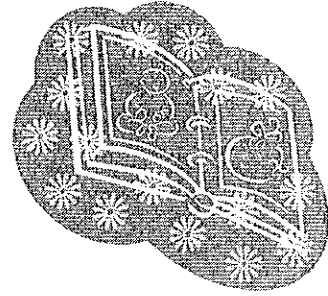

Have you made a list of your Unit officers? Are you taking pictures of special events that are happening in your Unit? Is your Legion family working together on any special projects? Has President Linda visited your Unit or Post? If so, send me a picture for Linda's History book. All of this is a part of your Units' history. We all say that we can remember what has happened over the years, but as we all know we don't....So put your best foot forward and start putting your Unit history together. You'll be glad you did!

*Shelley Riggs*  
Department Historian

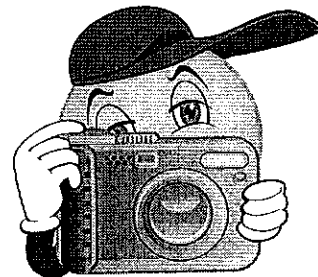

## National Security

Vicky Buck, Chairman  
Department of Ohio

Here we are in the middle of November, already! By the time you have read this, it is likely you have started your Christmas shopping. While you are out, let's not forget our Veterans and the families of our deployed soldiers. Why not purchase a \$10 or \$20 gift card (from Kroger, Meijer or Wal-Mart) and send it to me or Department President Linda Close so that we may send it on to RISFAC to give to those who need some help during the holidays. The Military Family Assistance Grant is here to help our military families, but not until after January, 2011. The need is immediate and gift cards can help now. The donations you make for gift cards will get credited to the Military Family Assistance Grant. I will also have a box at Mid-Winter Conference to collect any additional gift cards. President Linda's project is getting noticed by many organizations helping our military. We still need to continue to increase the fund with monetary donations. Please consider holding an event to raise awareness and funds for this great cause.

We have received information about the Heroes to Hometown program. There are many ways to help these special men and women serving our country. This program is designed to welcome home service members who have been injured and unable to return to their assignment. H2H establishes a support network and coordinates resources. Last year the American Legion's "Heroes to Hometowns" program assisted over 1,100 veterans. Support can include:



- Help paying the bills
- Finding suitable homes
- Adapting vehicles
- Transportation to appointments
- Child care support
- Welcome Home events
- Help in government benefits.

Units need to work within their local community to let them know we are willing to help. Every veteran and family may need something different. The holidays are approaching quickly and it's time we put the Power of One (Service not Self) to work. If you would like additional information go to [www.heroestohometowns@legion.org](http://www.heroestohometowns@legion.org).

During our Mid-Winter Conference, I will have handouts about the Cell Phones for the Soldiers and Coupon Clipping for the Military. Another piece of information I will have is the Kissing Pillow Project. I have been given permission to copy and distribute the directions to those members who wish to make them. They are not to be sold but are a gift for the soldiers and their families. These pillows are hand-stitched keep sakes for the children and loved ones left behind by soldiers deploying in the service of the United States of America. The soldier will kiss the pillow and

give one to each of his or her loved ones to hold onto. Conversely, all loved ones will kiss the one pillow that the soldier will take along on his or her deployment. These pillows become a comfort item during the lonely times for both the family and for the soldier.

Many of you have asked about **HAP - Handmade Afghan Project**. Unit members should bring their 6"x 9" rectangles to Mid-Winter Conference where I will be collecting them. If you are not making the trip to Columbus, give them to another Unit member or your District President to bring with them. I will be sorting and counting them in order to get them ready for the Put Together Events. On Friday evening, I will be working with our Central Division Vice President Donna Fueling, on the designing and crocheting together of the first ALA Ohio HAP afghan. If anyone would like to learn how to crochet an afghan together this is the time. I will also be teaching people at the District Put Together Events as well. The following Districts have reserved the following dates for their Put Together Event:



March 26, 2011	District 5 – Unit 12 – Elyria
April 2, 2011	District 1 – Unit 3 – Findlay
May 7, 2011	District 12 – TBD – <b>THIS WILL BE THE LAST ONE AS I WANT TO GET THEM ALL MAILED BEFORE MEMORIAL DAY.</b>

Mid-Winter Conference is just around the corner. The Friday night Awareness Assembly that Legislative Chairman, Mona Shipley and I are putting together will have **Susan Bogan**, a Troop & Family Assistance Center Specialist from the Ohio National Guard Family Readiness Program. She will be here to talk with us about family readiness and service member support through the programs with the Ohio National Guard. She also plans to discuss some legislative issues that pertain to service members. Plan to attend as it will be a great time with lots of information.

There are many ways you can help with the National Security Program in your Unit. Get involved in something and report your efforts. If you have any questions, please call me, e-mail me or snail mail me. I want to help you have a wonderful year with National Security.



Vicky Buck  
National Security Chairman  
708 S. Ogden Avenue  
Columbus, OH 43204  
(614) 596-8540  
[Lt248@aol.com](mailto:Lt248@aol.com)

# Poppy Program

Vicki Monroe  
7988 Asbury Hills Drive  
Cincinnati, OH 45255  
513-231-3572  
vmonroe@hwsusa.com

You might ask yourself when we start to promote the Poppy Program. The answer is “NOW”. The history and significance of the Poppy needs to be circulated all year long so that anyone you come in contact with will have the opportunity to hear the story and contribute to the welfare of our veterans. As Auxiliary members, it is our responsibility to have all types of information to share with all ages. You may get information on the ALA Ohio website under Programs. There are resources available to you there. You can also check out the National website for additional resources. Don’t stop there; use your creativity to get our message out about the poppy.

Make contact with your schools now to let them know about the opportunities the Auxiliary offers students who participate in the Poppy Poster Contest and the Miss Poppy Contest. You may even want to create your own Unit contest for the schools to participate in. The possibilities for contests are limitless, if you use your creative thoughts. A few suggestions may be a coloring contest for the younger students, a Thank You for serving card making contest that shows the poppy as the main theme and the ideas go on and on.

We have a new contest this year for the National Creative Arts Festival. Instead of the Poppy Corsage Contest, we will be having a **Poppy Usage Contest**. At Mid-Winter bring in your veteran made poppy item for display. It can be a corsage, but it can be almost anything -- a vase, wreath, hat, picture frame, etc. The top 5 vote getters will receive a prize and will be entered in the national contest at the awareness assembly. The items will be photographed for an 8 by 10 picture for submission. All entries will go home with the “artiste” at the end of Mid-Winter. Please read your POA for more information about the contest. The contest is not limited to one per Unit. Bring as many as you wish. I hope to see lots of great ideas.

See you at Mid Winter.

## HOME SERVICE

DO YOU HAVE MEMBERS IN YOUR UNITS WHO ARE ALWAYS SEWING, BAKING, CROCHETING, KNITTING OR DOING CRAFTS IN THEIR HOME FOR THE VETERANS???

HAVE YOU ASKED THEM TO KEEP TRACK OF THEIR HOURS AND MONIES TO SEND IN A REPORT ON THE HOME SERVICE FORMS????

DO YOU HAVE MEMBERS WHO DO COOKING, BABY SITTING IN THEIR HOMES WHILE THE VETERAN ATTENDS MEDICAL APPOINTMENTS OR A REHAB SESSION????

CHECK YOUR UNIT FOR THESE LADIES WHO DO ALL OF THESE LABORS OF LOVE FOR OUR VETERANS.

WE WOULD LOVE TO HEAR FROM ALL THE UNITS IN ALL 14 DISTRICTS.

LOIS SINGLETON  
HOME SERVICE PROJECT  
PH: 740-344-1904  
EMAIL: [loispat@hotmail.com](mailto:loispat@hotmail.com)

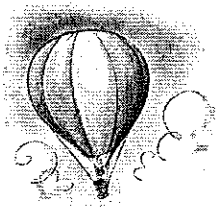

## HIGH ON PATRIOTISM

### HOMELESS VETERANS

Today our soldiers returning from the battlefields are facing many difficult issues. Our nation's veterans selflessly dedicated their lives often endured long periods of separation from loved ones not knowing if they would ever see them again.

Suicides are up as many returning home are battling emotional and/or physical disabilities. Despite the pain they have suffered, if you look in their eyes, you will often see a love for their country, strength for their families, and a courage that is indefinable.

The latest information from the national Coalition for Homeless Veterans shows 107,000 homeless veterans sleeping on the street every night and 5% of these are female veterans. As the homeless are transient, it is difficult to give an accurate number, it definitely is a tragedy and needs to be corrected.

In Abraham Lincoln's second inaugural address he said these famous words "*With malice toward none, with charity for all, with firmness in the right as God gives to see the right, let us strive on to finish the work we are in, to bind up the nation's wounds, to care for him who shall have borne the battle and for his widow and his orphan*".

Upholding his promise ought to be our greatest privilege as American citizens and auxiliary members.

How can we give back a little to these veterans that have sacrificed so much for us?

- A. Say "Thank you for your service".
  - B. Work with homeless shelters, stand-downs, and contact your congressman and ask that he address this issue.
  - C. Support Fide 2 Recovery.
  - D. Support Veterans Creative Arts Festival
  - E. Volunteer at your closest VAMC, Outpatient Clinic or Vet Center.
- A friendly face and a kind word can make a big difference in a patient's day.

## UPCOMING EVENTS AT VAMC'S

### GEORGETOWN

Employees from General Electric Aviation in Cincinnati will be sponsoring the Veterans Day Program at OVH.

Friday, November 12, 10:00 a.m.

Hamilton DAV Unit 15 Color Guard

National Anthem & God Bless America Sung by Emilee Saiter

Cincinnati Scots Pipe and Drum Band

GE Volunteers will Address OVH Veterans, Staff and Visitors

Lunch and Cake Served

Gift Packages to all Residents

We will also be having a Veterans Day Program on November 11<sup>th</sup> at 2:00 p. m. Mac McCary & the Pickers will be playing patriotic music.

### SANDUSKY

Soup & Bread Lunch

The 13<sup>th</sup> Annual Soup & Bread Lunch will be hosted by the Sandusky American Legion. Sandusky AMVETS & Chef Tod will be donating the ever popular variety of soups, and the Sandusky VFW will be providing assorted breads and crackers. Auxiliary members of the Volunteer Advisory Committee will be bringing desserts. Entertainment by Joe Hooker.

**NOVEMBER 30 – Serving from 11 to 1 p. m.**

**Tickets: \$7.00 \***

One hundred percent of the ticket price goes to granting Christmas wishes for our veterans, making it 100% tax deductible. What a great way to help our veterans and show you care.

Please make your check out to OVH-VAC, and send it to Eugene Fitzthum, Chairman, OVH\_VAC, 3416 Columbus Ave., Sandusky, OH. 44870.

**CHRISTMAS HAND OUT** – Dayton Dec. 10<sup>th</sup> @ 10:00 a.m., OVH Sandusky- Dec. 14<sup>th</sup>, 8:30 a.m., Need Help.

## VETERANS HOMES NEEDS

### CICINNATI VA NEED LIST

DITTY BAGS – 8” X 12” WITH DRAW STRING CLOSURE  
NYLON BATH SPONGES  
BIG COMBS AND HAIR BRUSHES  
POSTAGE STAMPS AND BLANK CARDS  
MEN AND LADIES SOCKS  
BIG PRINT WORD SEARCH AND SUDUKO

OTHER ITEMS THAT CAN BE USE;  
DENTURE CREAM AND TOOTH PASTE  
ALCOHOL FREE MOUTHWASH  
LOTION  
BATH GEL/WASH  
HAND SANITIZER  
PLAYING CARDS  
PLEASE DO NOT SEND NO PERFUMES,STYLING GEL, AFTER SHAVE OR HAAIRSPRAY BECAUSE OF ALCOHOL CONTENT.

### COLUMBUS VA AMBULATORY CARE CENTER

Bus Passes (Day Passes)	Phone Cards
Homeless Veteran Program	Coffee/Snacks
Ditty Bags	Ensure (Oncology)
Towels/Wash Clothes	
Haircut Vouchers	
Laundry Tokens	
Gas Cards	
Laundry Detergent (Trial Size)	
Duffel Bags	
Food Vouchers (Local Fast Food or Resturants)	
Underware (Assorted sizes)	
Socks	
T-shirts (Assorted sizes)	
Smoking Cessation class Supplies (Ice Breaker Gum, Sugar Free Hard Candy,Sugar Free Snackwells)	

**Thank you and may God bless you for helping our wounded warriors.**

**DONATION LIST FOR OHIO VETERANS HOME**, June Downs, 3416 Columbus Avenue, Sandusky, Ohio 44870

Combs	Toothpaste	Denture Adhesive	Paint By Numer	Board Games	Models
Baby Oil	Hand Soap (Liquid)	Hand Lotion	Paper& Pins	Wall Clocks	Craft Kit
Denture brushes	Kleenex	Denture Cleaner	Books on Tape	CD's& DVDs	
Mouthwash *	Deodorant (spray/roll on)	Shaving soap, cream/lotion		Card Decks	

Chapstick                  Shampoo                  Nail Clippers  
Bar Soap

**\*ALCOHOL FREE No Hotel Samples Please. We don't have room for books, puzzles, magazines.**

**LOUIS STOKES WADE PARK VA HOSPITAL WISH LIST**

Razors (2 edges please)	Sugar Free Gum	Combs
Shaving cream	Puzzle Books (crossword and Sudoku)	Brushes
Toothbrushes	Word Search Books (if	Socks(white. XL)
Toothpaste	Hard Candy	
Mouthwash	Deodorant	
Tootsie Rolls	Lotion	
Gum (they love Big Red & Wintergreen)	Shampoo	
Sugar Free Candy	Baby Powder	
Sugar Free Gum		
Word Search Books (if you can find large print for both they are always appreciated)		
Magazines for Men ( sports, fishing, hunting, racing car)in good condition does not matter if old		
Ditty Bags		
Lap Robes		
Wheel Chair Bags – sturdy material in prints and solid, Remember these are mostly for men		

**DONATIONS FOR GEORGETOWN**

Pat Michalski  
Ohio Veterans Home  
2003 Veterans Blvd.  
Georgetown, Ohio 45121

\*Adopt-A-Vet Program, support for residents without income

\*Monetary donations to support gasoline purchases for activities & special trips

\*Books of postage stamps for mailing cards to loved ones

\*Prizes for bingo games - \$50/month

Combs	Toothpaste	Denture Adhesive
Baby Oil	Hand Soap (Liquid)	Hand Lotion
Mouthwash*	Deodorant (Spray/roll on)	Denture Cleaner
Denture brushes	Kleenex	Chapstick
Shampoo	Nail Clippers	Bar Soap
Shaving soap, cream/lotion		

**\*ALCOHOL FREE**

Paint by Number	Board games	Model kits-Cars, planes, etc
Paper & pens	Craft Kits	Books on Tape
CD's, DVD's	Pinochle cards	

**\*PLEASE MAKE CHECKS TO OVH COMMITTEE AND DESIGNATE WHICH FUND YOU ARE CONTRIBUTING TOO. IF NOT IT WILL BE PLACED IN GENERAL FUND TO BE USED AS NEEDED.**

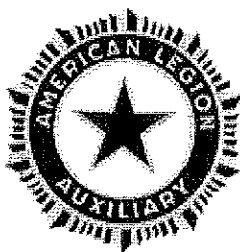

**Dayton VAMC  
Items we need all year**

*Dayton VAMC sees approximately 65 veterans each Monday.  
The residents continually need resupplied with these items.  
Thank you.*

**Contents of Diddy Bags:**

**3 razors  
1 can of shaving cream  
Writing paper  
Envelopes and Stamps  
1 pen  
1 large tube of toothpaste  
1 toothbrush  
1 large bar of soap  
1 container of shampoo  
1 bottle of hand lotion  
1 container of foot powder  
1 container of baby powder  
1 stick of deodorant  
1 comb or brush**

**We could use more diddy bags, big print word search, denture cleanser, men's new underwear, notebooks and phone cards.**

**MASTER INVENTORY FOR AUXILIARY OFFICE AT  
DAYTON VA MEDICAL CENTER**

--

shampoo	undershirt
conditioner	undershorts
comb/brush	socks
soap	hat
deodorant	gloves
powder	scarf
lotion	lap robe
toothbrush	slippers (skid resistant)
toothpaste	shoe laces
denture cleaner	phone card
Denture adhesive	writing tablet
mouthwash (non-alcoholic)	envelopes
razor	postage stamps
shaving cream	playing cards
after shave (non-alcoholic)	puzzle books
cotton swabs	greeting cards
cotton balls	wallet/coin purse
tissues (box or pocket size)	nail clippers
chap stick	
microwave popcorn	
individually wrapped candy	

Special requests or Christmas:
clock radios
watches
blankets
long sleeve t-shirts

Carol Kelly, Chief Representative  
937/439-1442

Ola Mathews, Deputy Representative  
937/439-1442

VA Medical Center  
17273 State Route 104, Chillicothe, Ohio 45601  
(740) 773-1141, ext. 7420

**WHEELCHAIR BAG**

Note: These wheelchair bags will be used by patients to carry their records and other items on the back of their wheelchairs when traveling from building to building. A strong heavy material such as denim, canvas, etc. should be used. However, if using thinner material, reinforcing the material by doubling it is suggested. Only "one-large pocket" bags are needed versus the two pockets used in the past.

1. CUT:

- Back of bag (2 pieces of heavy fabric)  
24 1/4 X 20 1/2 inches
- Front of bag (1 piece of heavy fabric)  
20 1/2 X 20 1/2 inches
- Ties (twill tape or other sturdy material)  
2 pieces no less than 18 inches each (to allow for easier fastening, longer would be better)
- Velcro strip at least 5 inches

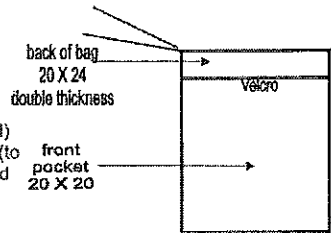

2. SEW POCKET:

Finish top edge of pocket (serge or turn 1/2"; turn under again 1/2"  
Sew (at sides and bottom) wrong side of pocket to one of the right back pieces. Use 1/4" seam allowance.

3. SEW BAG:

Pin right side of back piece to the right side of the back piece (that now has the approximately 20" X 19" pocket attached).  
Leaving an opening to turn inside out (bottom or top), use 3/8" seam. Stitch around the bag on all four sides.  
Trim corners. Turn and press. Sew close opening (hand, machine, adhesive web, etc.).

4. FINISH BAG:

Optional: Topstitch around bag.  
Sew ties to the upper edge of the back. Reinforce several times.  
Sew Velcro to the inside of the back and inside of the pocket top.

**DITTY BAGS**

These bags can be made from any type of cloth material. Finished size should be 9"X13". One 9" end should be left open with a 1" hem (open at both sides to allow for insertion of drawstring). (We will insert the drawstring.) The ditty bags are filled with toiletries, stationary, etc., by the American Legion Auxiliary and distributed to patients upon admission to the Medical Center. Ditty bags are in constant demand.

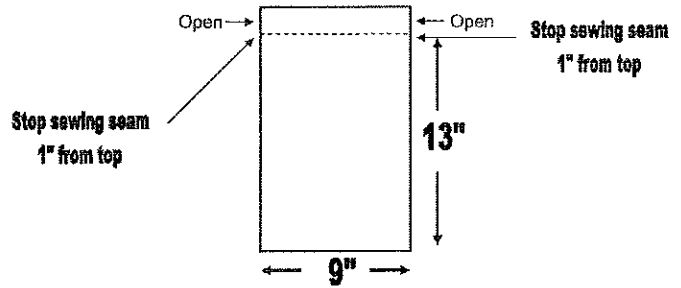

**TOWEL BIBS**

Bibs are mostly for geriatric patients who have difficulty eating to help keep them neat and clean. They must be made from terry cloth or towels, and should long enough to cover the patient's lap. Cut out a circle at one end for the neck. Turn approximately 5/8" of edge of circle (neckline) under once, and stitch several times (or zigzag) to reinforce against fraying. Attach Velcro tabs to ends of neckline.

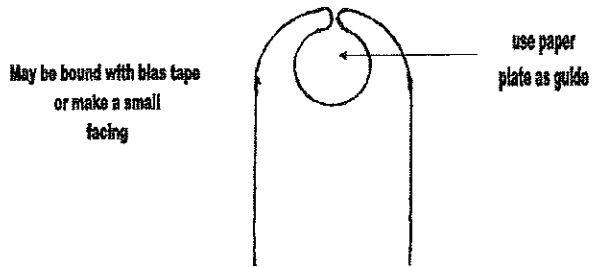

Wheelchair caddies can be made from any heavy fabric. They are 24" x 22" with a pocket sewn to the front. Loops can be made from any fabric and sewn on the top ends to hang over the push handles of the wheelchair. Loops should be at least 4" - 6" long. Taper in the bottom of the caddy to avoid getting caught in the spokes of the wheels.

Finished Size 24" x 22"

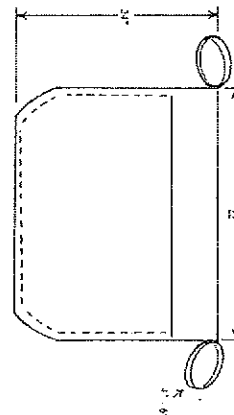

**WHEELCHAIR CADDIES**

For OVH Sanclarksky

OVH Sandusky

# PRIMARY DRAINAGE BAG HOLDER

bags can be made from any heavy fabric. They should be 1 inch deep by 12 inches wide. Straps should be made from a rough surfaced fabric which will grip as shown in the illustration.

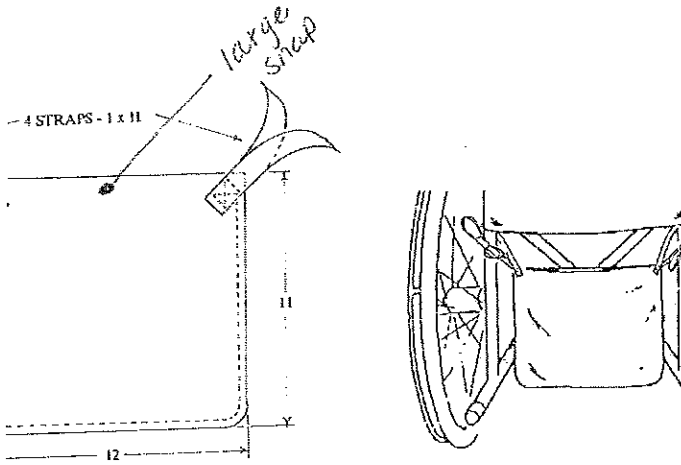

## V. A. & R MID YEAR REPORT

Due to Department Chairman by **December 15, 210**

Jeanie Gibson, 225 W. South St. , Carey, OH 43316

Unit Participation: **Homeless Activities** \_\_\_\_\_ Stand Downs \_\_\_\_\_

Veterans Served \_\_\_\_\_ Home \_\_\_\_\_ Volunteer hrs. \_\_\_\_\_ Cost to Units \_\_\_\_\_

**Welcome Celebrations sponsored by VA facility** \_\_\_\_\_

No. of military/families served \_\_\_\_\_ Vol. hrs. \_\_\_\_\_ No. of volunteers \_\_\_\_\_

**Veterans Creative Arts Festival** \_\_\_\_\_ Donations to Department/National  
\$ \_\_\_\_\_ Vol. hrs. \_\_\_\_\_ Donations local \$ \_\_\_\_\_ Vol. hrs. \_\_\_\_\_ Veterans  
served \_\_\_\_\_

**Ride 2 Recovery** \_\_\_\_\_ Volunteer hours \_\_\_\_\_ In-kind/monetary donations \$ \_\_\_\_\_

Wounded warriors sponsored \_\_\_\_\_ Amount \$ \_\_\_\_\_

Support Spinning Recovery labs/Outdoor cycling at military bases & VA  
facilities \_\_\_\_\_ No of veterans/military families' served \_\_\_\_\_

**Does your Unit support Fisher Houses?** \_\_\_\_\_ No. of volunteers \_\_\_\_\_  
Hours \_\_\_\_\_ Unit Cost \$ \_\_\_\_\_

**VA Facilities:** No. of Unit Regularly Scheduled Volunteers \_\_\_\_\_ Occasional  
volunteers \_\_\_\_\_ No. new Regularly Scheduled Volunteers \_\_\_\_\_ No. of new  
Occasional volunteers \_\_\_\_\_ Field Service Volunteers \_\_\_\_\_ No of new Field  
Service vol. Home Service volunteers \_\_\_\_\_ No. of new Home Service Vol. \_\_\_\_\_  
Total hrs. \_\_\_\_\_ Veterans Served \_\_\_\_\_

**Does your Unit promote special activities for women veterans/military?** \_\_\_\_\_

No. of women served \_\_\_\_\_ Unit Cost \$ \_\_\_\_\_

Write on back any activities your unit does for our veterans.

Are you ready for Christmas?  
Do you have all your gifts for under the tree?

What about stocking gifts?  
Do you have something ready for an exchange  
gift if one comes up at the last minute?



**If not, how about a patriotic American Legion Auxiliary charm bracelet for that special daughter, grand (or great-grand) daughter; perhaps one for the Junior Auxiliary member in your life.**

**These gifts are inexpensive and sized to fit; charms can be chosen from a large selection to match the personality of the recipient.**

**The basic bracelet (18 links of either all silver (\$5) or silver trimmed in gold) for \$10, and all charms are priced at \$5 each. Go to the Dept of Ohio web-site ([www.alaohio.org](http://www.alaohio.org)) and click on resources, forms, charm order: \*\* Double click on the charms shown and see them up close and in better detail. Start with the ALA emblem, add the service branch that represents your eligibility (Army, Navy, Air Force, Marines, Coast Guard or National Guard). From there you can choose Ohio charms (Ohio flag, cardinal), patriotic (US flag, Support our Troops, POW/MIA or whimsical (flag waving bear, black motorcycle, etc.).**

**Download the order form from the ALA web-site, or you can call ALA Dept office in Zanesville (740) 452-8245 and place your order over the phone. Either way, your bracelet can be mailed to you for a flat fee of \$3.50 or (if you prefer) it can be delivered to you (at no cost) at the next Dept function (Mid-Winter for example).**

ALA emblem, Pray for our Troops, Cardinal, US flag



Twin towers, USA, Bear with a Heart, Patriotic Heart

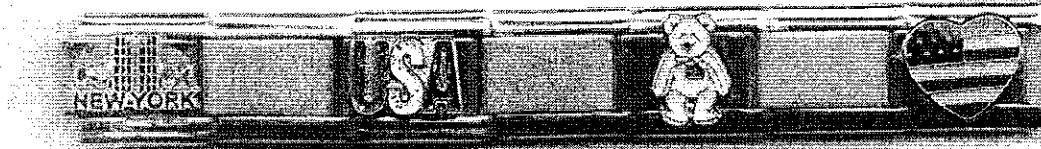

Blue Star Banner, Poppy, Ohio flag, Black motorcycle

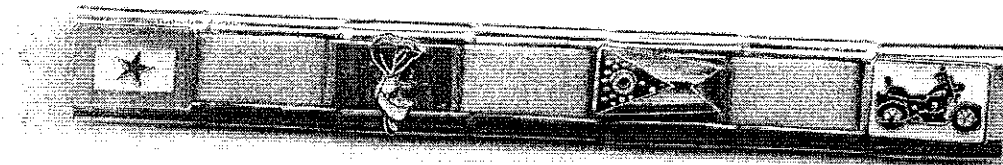

US Navy, Coast Guard, US Marine Corps

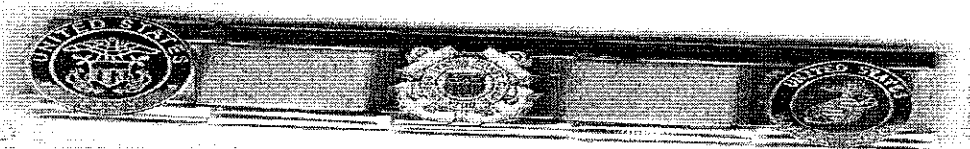

Support our Troops, POW/MIA, US Army



US Air Force, Army National Guard



# NORMAN ROCKWELL MOMENTS™

Every order earns 15% of the purchase price for your Department (less taxes and shipping) plus great savings.



**From Your Photo to Personalized Art...a Unique Keepsake that can never be duplicated! You may include ALA emblem at no extra charge.**

Famed artist Norman Rockwell created classic images that celebrate the American spirit as no other artist in history. Now a favorite portrait photo can be transformed into beautiful and timeless artwork in the style of Norman Rockwell.



Norman Rockwell-style portraits are ideal for special occasions, recognitions and gifts. The photo is rendered in charcoal or color by skilled artists using patent-pending, computer-based procedures that capture the lighting, brush strokes and other unique techniques used by Norman Rockwell. This is the only process licensed by the Norman Rockwell licensing company and allowed to carry the Rockwell brand.

**Special for members and friends of the American Legion Auxiliary**

# FREE

**When you order any portrait, at the special price of \$129, receive a free second printing of that portrait to share with friends or family.**

Color or charcoal - 8 x 10 image on 11 x 14, or 11 x 14 image on 16x20. Both on museum quality, acid-free paper, unframed, plus taxes, shipping and handling. Use coupon code "AUX129" plus state postal code for this special offer - example: AUX129NY or AUX129OH

**[www.normanrockwellmoments.com](http://www.normanrockwellmoments.com) | 1-800-754-2165**

**Come to our website and see our entire sample gallery!**



Every order earns 15% of the purchase price for your Department (less taxes and shipping) plus great savings.

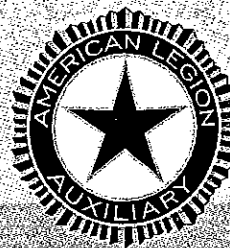

**A Unique Keepsake of your pet that can never be duplicated!**

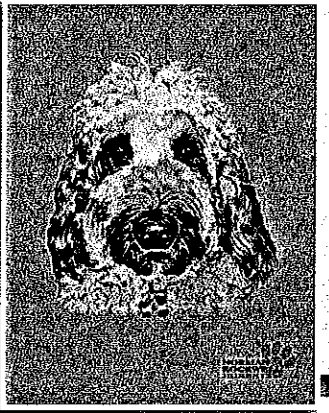
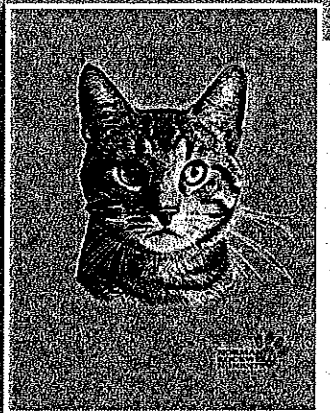
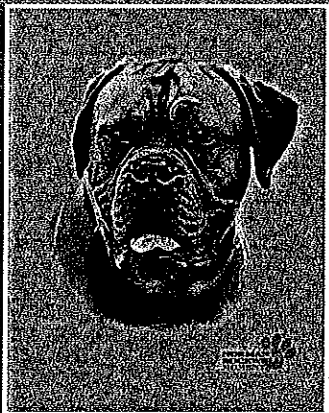
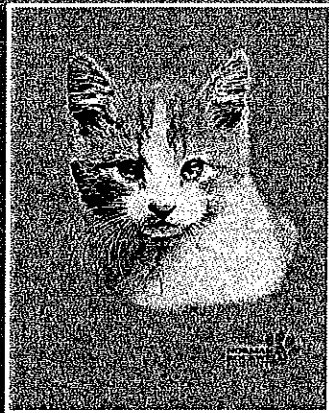

Now, *Norman Rockwell Moments* makes it possible for you to honor your pets with a legacy work of art to be treasured as a **one-of-a-kind** keepsake: a *Norman Rockwell Moments* pet portrait!

Your pet's photo is rendered in charcoal or color by skilled artists using a unique patent-pending process and printed on elegant, acid-free, archival paper.

**Special for members and friends of the American Legion Auxiliary**

**FREE**

**When you order any portrait, at the special price of \$129, receive a free second printing of that portrait to share with friends or family.**

Color or charcoal – 8 x 10 image on 11 x 14, or 11 x 14 image on 16x20. Both on museum quality, acid-free paper, unframed, plus taxes, shipping and handling. Use coupon code **"AUX129"** plus state postal code for this special offer – **example: AUX129NY or AUX129OH**

**[www.normanrockwellmoments.com](http://www.normanrockwellmoments.com) | 1-800-754-2165**

**Come to our website and see our entire sample gallery!**